

Montage- und Betriebsanleitung

EN Installation and operating instructions
ES Instrucciones de montaje y servicio
CS Návod pro montáž a provoz
FR Notice de montage et de mise en service

NL Montage- en bedrijfsinstructies
PL Instrukcja montażu i obsługi
SV Monterings- och driftinstruktion
HU Szerelési és használati útmutató
FI Asennus- ja käyttöohje

EL Συναρμολόγηση και οδηγίες λειτουργίας
IT Istruzioni per il montaggio e l'uso
RO Montaj și instrucțiuni de funcționare
RU Инструкция по монтажу и вводу в эксплуатацию

AQUA205
7612982080432
2186 00 23

AQUA205W
7612982080456
2186 01 23

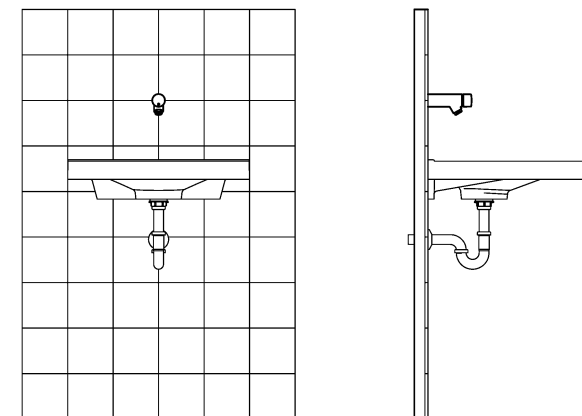
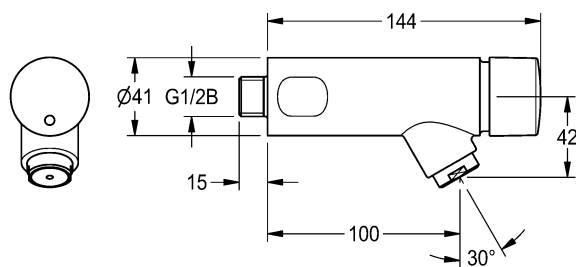
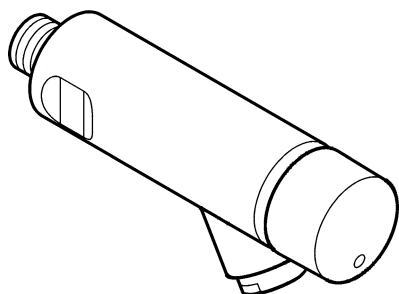

EN Important notes Before installing flush piping system!	NL Belangrijke aanwijzingen Voor installatie buisleidingen spoelen!	EL Σημαντικές οδηγίες Πριν από την εγκατάσταση ξεπλύνετε τις σωληνώσεις!
FR Remarques importantes Rincer les conduites avant d'installer !	PL Ważne wskazówki Przed instalacją przepłukać rury!	IT Avvertenze importanti Sciacquare le tubazioni prima di installare!
DE Wichtige Hinweise Vor Installation Rohrleitungen gemäß DIN 1988 spülen!	SV Viktiga informationer Spola igenom rörledningarna före installation!	RU Важные указания Перед инсталляцией промыть трубки!
ES Indicaciones importantes ¡Enjuagar las tuberías antes de instalar!	HU Fontos utasítások Telepítés előtt öblítse át a csővezetékeket!	RO Indicații importante A se spăla conductele de țevi înainte instalației!
CS Důležité pokyny Před instalací potrubí propláchněte!	FI Tärkeitä ohjeita Huuhtelee putkijohdot ennen asennusta!	

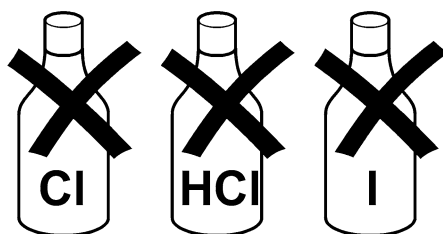

www.franke.com
www.franke.de

EN Technical data		FR Données techniques	
Minimum flow pressure	1,0 bar	Pression dynamique minimale	1,0 bar
Maximum operating pressure	10 bar	Pression de service maximale	10 bars
Recommended flow pressure	3 bar	Pression dynamique recommandée	3 bars
Volume flow	0,10 l/s	Débit volumique	0,10 l/s
Flow duration	5 - 20 s adjustable	Durée d'écoulement	5 - 20 s réglable
DE Technische Daten		ES Datos técnicos	
Mindestfließdruck	1,0 bar	Presión mínima de flujo	1,0 bar
Maximaler Betriebsdruck	10 bar	Presión máxima de servicio	10 bares
Empfohlener Fließdruck	3 bar	Presión de flujo recomendada	3 bares
Volumenstrom bei 3 bar Fließdruck	0,10 l/s	Flujo volumétrico	0,10 l/s
Fließzeit	5 - 20 s einstellbar	Tiempo de corriente	5 - 20 s ajustable
NL Technische gegevens		PL Dane techniczne	
Minimale dynamische druk	1,0 bar	Minimalne ciśnienie przepływu	1,0 bar
Maximale werkdruk	10 bar	Maksymalne ciśnienie robocze	10 barów
Aanbevolen dynamische druk	3 bar	Zalecane ciśnienie przepływu	3 barów
Volumestroom	0,10 l/s	Objętościowe natężenie przepływu	0,10 l/s
Stromingstijd	5 - 20 s instelbaar	Czas przepływu	5 - 20 s z możliwością ustawienia
SV Tekniska data		FI Tekniset tiedot	
Minsta hydrauliska tryck	1,0 bar	Vähimmäisvirtauspaine	1,0 bar
Maximalt driftryck	10 bar	Suurin käyttöpain	10 bar
Rekommenderat hydrauliskt tryck	3 bar	Suosittelava virtauspaine	3 bar
Volymström	0,10 l/s	Tilavuusvirta	0,10 l/s
Flyttid	5 - 20 s inställbar	Juoksuaika	5 - 20 s säädettävissä
IT Specifiche tecniche		RU Технические характеристики	
Pressione idraulica min.	1,0 bar	Минимальный гидравлический напор	1,0 бар
Pressione di esercizio max.	10 bar	Максимальное рабочее давление	10 бар
Pressione idraulica consigliata	3 bar	Рекомендуемый гидравлический напор	3 бар
Portata volumetrica	0,10 l/s	Объемный расход	0,10 л/сек
Durata di flusso	impostabile da 5 - 20 s	Время протекания	5 - 20 сек. регулируемое
CS Technické údaje		HU Műszaki adatok	
Minimální průtočný tlak	1,0 bar	Minimális áramlási nyomás	1,0 bar
Maximální provozní tlak	10 bar	Maximális üzemi nyomás	10 bar
Doporučený průtočný tlak	3 bar	Javasolt áramlási nyomás	3 bar
Průtok	0,10 l/s	Volumenáram	0,10 l/s
Doba průtoku	nastavitelná 5 - 20 s	Áramlási idő	5 - 20 s között állítható be
EL Τεχνικά στοιχεία		RO Datele tehnice	
Ελάχιστη πίεση ροής	1,0 bar	Presiune minimă a curgerii	1,0 bar
Μέγιστη πίεση λειτουργίας	10 bar	Presiune maximă de funcționare	10 bari
Προτεινόμενη πίεση ροής	3 bar	Presiune de curgere recomandată	3 bari
Ρυθμός ογκομετρικής παροχής	0,10 l/s	Fluxul volumic	0,10 l/s
Χρόνος ροής	5 - 20 s ρυθμιζόμενος	Timp de curgere	Reglabil de la 5 - 20 s

Montage

EN Installation
FR Montage
ES Montaje
CS Montáž

NL Montage
PL Montaż
SV Montering
HU Szerelés
FI Asennus

EL Συναρμολόγηση
IT Montaggio
RU Монтаж
RO Montaj

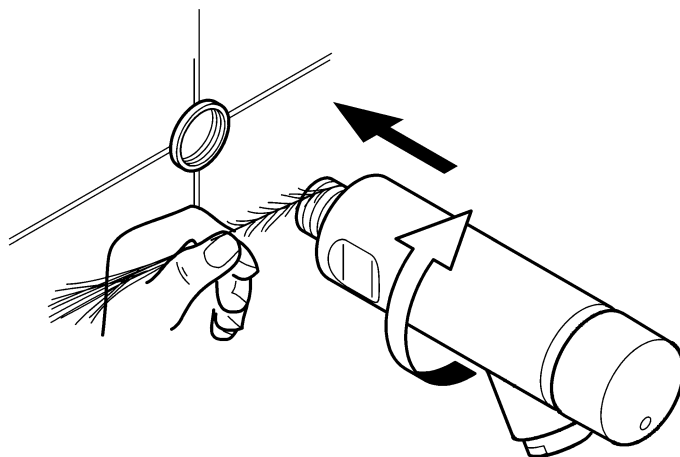

Funktion

EN Function
FR Fonctionnement
ES Función
CS Funkce

NL Werking
PL Funkcja
SV Funktion
HU Funkció
FI Toiminto

EL λειτουργία
IT Funzionamento
RU Функционирование
RO funcție

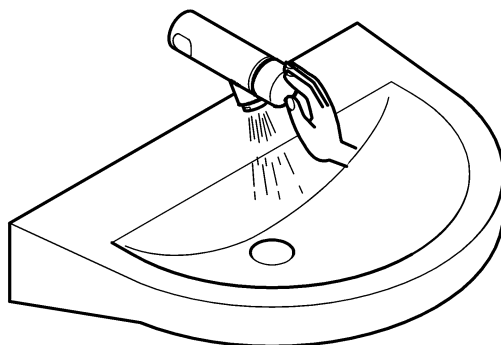

Fließzeit einstellen

EN Adjust flow duration
FR Régler la durée d'écoulement
ES Ajustar el tiempo de flujo
CS Nastavit dobu průtoku

NL Stroomingstijd instellen
PL Ustawić czas przepływu
SV Ställa in flytförmigan
HU Áramlási idő beállítás
FI Aseta virtausaika

EL Ρύθμιση του χρόνου ροής
IT Impostazione della durata di flusso
RU Регулировка времени истечения
RO A se regla timpul de curgere

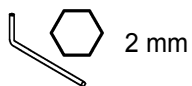

1

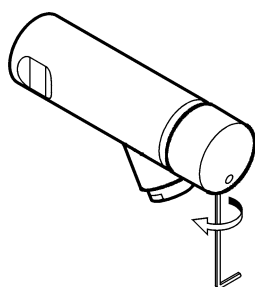

2

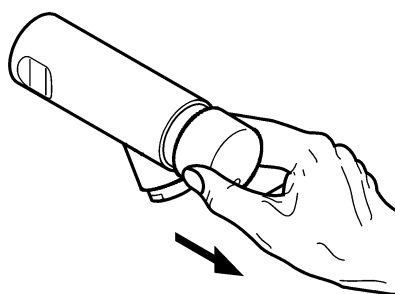

3

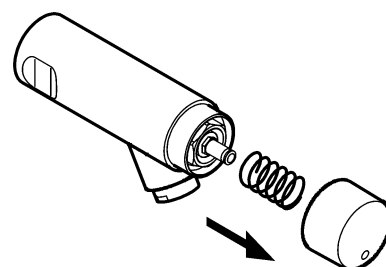

4

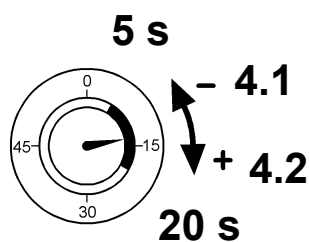
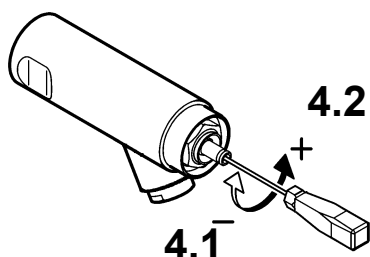

Wartung

EN Maintenance
FR Maintenance
ES Mantenimiento
CS Varování

NL Onderhoud
PL Konserwacja
SV Underhåll
HU Figyelmeztetés
FI Huolto

EL Προειδοποίηση
IT Manutenzione
RU Техническое обслуживание
RO Avertisment



1

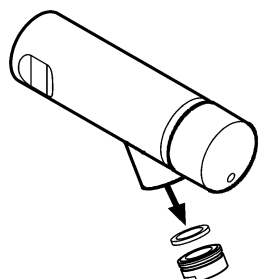

2

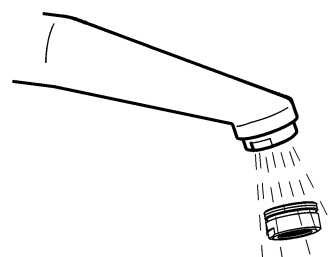

Funktionsteil ausbauen

EN Remove functional part
FR Démontez l'élément fonctionnel
ES Desmontar la pieza funcional
CS Demontovat funkční díl

NL Functie-element demonteren
PL Wymontować element funkcjonalny
SV Bygga ut funktionsdelen
HU Funkcionális elem kiszérése
FI Kunnossapito

EL Αφαίρεση τμήματος λειτουργίας
IT Smontaggio dell'elemento funzionale
RU Демонтаж функциональной детали
RO A se demonta piesa funcțională

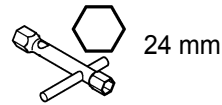
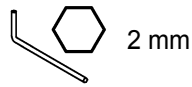

- 1** EN Interrupt the water supply
FR Interrompre l'alimentation en eau
DE Wasserzufuhr unterbrechen
ES Interrumpir el suministro de agua
NL Watertoevoer onderbreken
PL Odciąć dopływ wody
SV Avbryta vattentillförseln
FI Keskeytä vedensyöttö
IT Interrompere l'alimentazione dell'acqua
RU Прекращение подвода воды
CS Přerušit přívod vody
HU Vízbetáplálás megszakítása
EL Διακοπή παροχής νερού
RO A se întrerupe alimentația cu apă

2

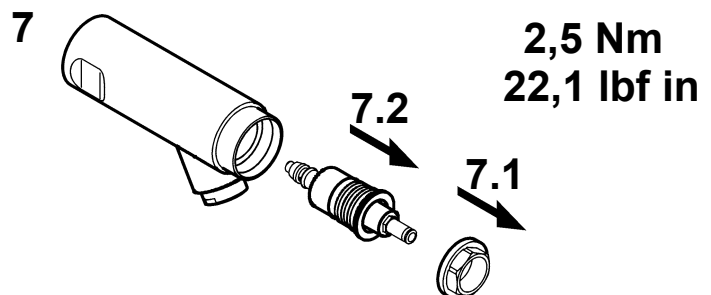
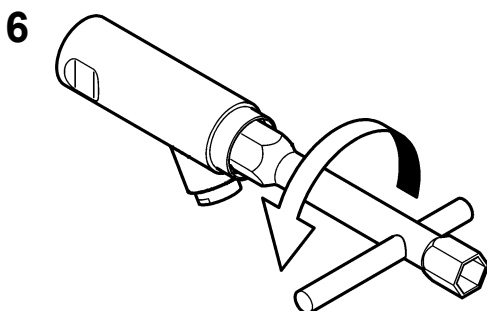
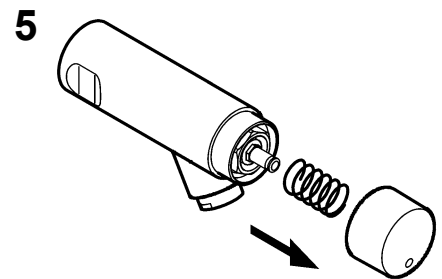
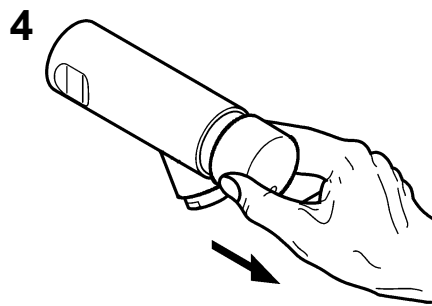
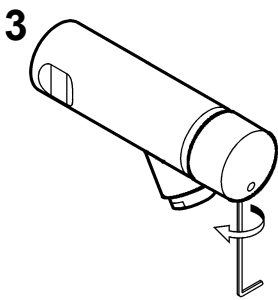
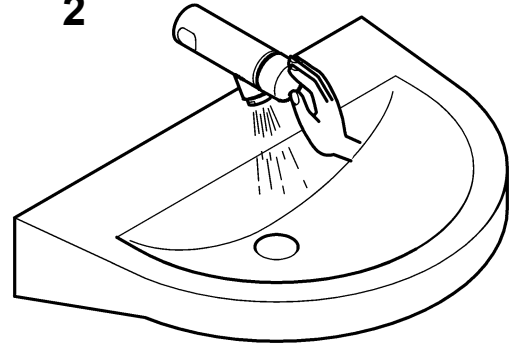

Ersatzteile

EN Replacement parts
FR Pièces de rechange
ES Piezas de recambio
CS Náhradní díly

NL Reserveonderdelen
PL Części zamienne
SV Reservdelar
HU Pótalkatrészek
FI Varaosat

EL Ανταλλακτικά
IT Pezzi di ricambio
RU Запчасти
RO Piese de schimb

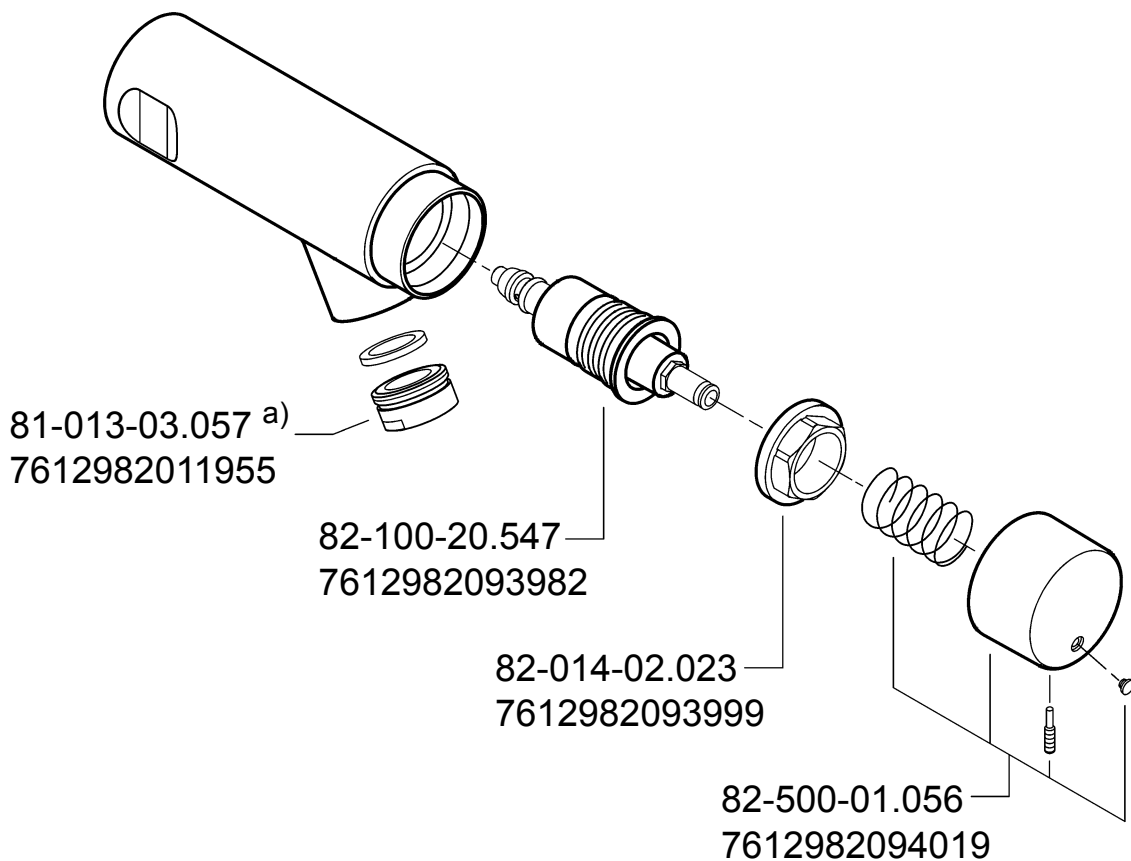

EN a) 10 pieces	FR a) 10 pièces	DE a) 10 Stück	ES a) 10 piezas	CS a) 10 kusů
NL a) 10 stuk	PL a) 10 sztuk	SV a) 10 styck	HU a) 10 darab	FI a) 10 kappaletta
EL a) 10 τεμάχια	IT a) 10 pezzi	RU a) 10 штук	RO a) 10 bucăți	

WELL Public
Water Efficiency Label

AQUA205

Hersteller: **Franke Aquarotter GmbH**
 Produktkategorie: **Waschtischarmatur**
 Typ: **Zeit-/Sensorarmatur**
 Modell: **AQUALINE-S Wandventil**
 Registrierungsnummer: **WA10051-20101015**



Wasser Effizienz Kriterien

Durchfluss > 6,0 l/min ≤ 9,0 l/min	*	
Durchfluss geregelt ≥ 4,0 l/min ≤ 6,0 l/min	**	▶
Durchflussunabhängige Temperatureinstellung	*	
Temperaturbegrenzung / Kaltwasserventil	**	▶
Selbstschlussarmatur	*	▶
Sensorarmatur	**	

Informationen Betrieb und Montage: www.well-online.eu.
 A Label of EUnited Valves
 European Valve Manufacturers Association

WELL Public
Water Efficiency Label

AQUA205

Manufacturer: Franke Aquarotter GmbH
 Product category: Wash basin valve
 Type: Time/sensor valve
 Model: AQUALINE-S Wandventil
 Registration number: WA10051-20101015



Water Efficiency Criteria

Flow rate > 6,0 l/min ≤ 9,0 l/min	*
Controlled flow rate ≥ 4,0 l/min ≤ 6,0 l/min	** ←
Flow-independent temperature setting	*
Temperature limit / Cold water valve	** ←
Self-closing valve	* ←
Sensor valve	**

Information about use and installation: www.well-online.eu.

A Label of EUnited Valves

European Valve Manufacturers Association

WELL Public
Water Efficiency Label

AQUA205W

Hersteller: Franke Aquarotter GmbH
 Produktkategorie: Waschtischarmatur
 Typ: Zeit-/Sensorarmatur
 Modell: AQUALINE-S Wandventil
 Registrierungsnummer: WA10057-20101015



Wasser Effizienz Kriterien

Durchfluss > 6,0 l/min ≤ 9,0 l/min	*
Durchfluss geregelt ≥ 4,0 l/min ≤ 6,0 l/min	**
Durchflussunabhängige Temperatureinstellung	*
Temperaturbegrenzung / Kaltwasserventil	**
Selbstschlussarmatur	*
Sensorarmatur	**

Informationen Betrieb und Montage: www.well-online.eu.
 A Label of EUnited Valves
 European Valve Manufacturers Association

WELL Public
Water Efficiency Label

AQUA205W

Manufacturer: Franke Aquarotter GmbH
 Product category: Wash basin valve
 Type: Time/sensor valve
 Model: AQUALINE-S Wandventil
 Registration number: WA10057-20101015



Water Efficiency Criteria

Flow rate > 6,0 l/min ≤ 9,0 l/min	*
Controlled flow rate ≥ 4,0 l/min ≤ 6,0 l/min	** ←
Flow-independent temperature setting	*
Temperature limit / Cold water valve	**
Self-closing valve	* ←
Sensor valve	**

Information about use and installation: www.well-online.eu.
 A Label of EUnited Valves
 European Valve Manufacturers Association

ALG

SARL BFIX
Résidence Chaabani
Val d'Hydra part N°06-C Hydra 08
DZ-16035 HYDRA-ALGER / Algeria
t: +213-(0)21 60 13 60
e: customer@bfixgroupe.com

AUT

Franke Ges.m.b.H
Oberer Achdamm 52
6971 Hard / Austria
t: +43-(0)5574-6735-0
e: ws-info.at@franke.com

BEL

Franke N.V.
Ring 10, PB 117
9400 Ninove / Belgium
t: +32-(0)54-310130
e: ws-info.be@franke.com

CAN

Franke Kindred Canada Limited
1000 Franke Kindred Road
L4R 4K9 Midland, Ontario / Canada
t: +1-705-526-5427
t: +1-866-687-7465 (toll free)
t: +705-526-4764 (local)
e: ws-info.ca@franke.com

CZE

Franke s.r.o.
Kolbenova 17
19000 Praha 9 / Czech Republic
t: +420-281-090-429
e: ws-info.cz@franke.com

EGY

Franke Kitchen Systems Egypt S.A.E.
1st Industrial Zone
6th October City, Cairo / Egypt
t: +20-(0)2-828-0000
e: ws-info.eg@franke.com

FIN / SWE / NOR / DEN

Franke Finland Oy
Vartiokuja 1
76850 Naarajaervi / Finland
t: +358-(0)15-3411-1
e: ws-info.fi@franke.com

FRA

Franke Ges.m.b.H
Oberer Achdamm 52
6971 Hard / Austriche
t: 0800 909 216
e: ws-info.fr@franke.com

GBR / IRL

Franke Sissons Ltd.
Carrwood Road
Chesterfield S41 9QB / United Kingdom
t: +44-(0)1246-450-255
e: ws-info.uk@franke.com

GER

Franke Aquarotter GmbH
Parkstrasse 1 - 5
14974 Ludwigsfelde / Germany
t: +49-(0)3378-818-0
e: ws-info.de@franke.com

GEO

Franke Caucasus Ltd.
7, Agladze Street
Tbilisi, 0154 / Georgia
t: +995-(0)32-351672
e: info@franke-ge.com

ITA

Franke Ges.m.b.H
Oberer Achdamm 52
6971 Hard / Austria
t: 800-789233
e: ws-info.it@franke.com

NED

Franke N.V.
Ring 10, PB 117
9400 Ninove / Belgium
t: +31-(0)88-0027-368
e: ws-info.nl@franke.com

POL

Franke Aquarotter GmbH
Parkstrasse 1-5
14974 Ludwigsfelde / Germany
t: +48 (0)22 711 67 16
e: tomasz.skorupa@franke.com

POR

Franke Portugal S.A.
Estrada de Talaide, Edificio 3, Cruzamento
de Sao Marcos, 2735-531 Cacém / Portugal
t: +351-(0)21-426-9670
e: ws-info.pt@franke.com

RSA

Franke Kitchen Systems (Pty) Ltd.
1194 South Coast Road
4060 Mobeni / South Africa ZAF
t: +27-(0)31-450-6300
e: ws-info.za@franke.com

RUS

Franke Neva GmbH
Volgogradsky prospect 47, office103
109316 Moscow / Russia
t: +7 (0) 495 225 56 58
e: fs-info.ru@franke.com

SLO

Barjans d.o.o.
Pod Hruševco 20
1360 Vrhnika / Slovenia
t: +386-(0)1-750-66-40
e: info@barjans.si

SUI

Franke Washroom Systems AG
Franke-Strasse 9, Postfach 237
4663 Aarburg / Switzerland
t: +41-(0)62-787-3131
e: ws-info.ch@franke.com

SVK

INGEMA s.r.o.
Močarianska 1
071 01 Michalovce / Slovakia
t: +421-(0)56-640-36-12
e: ingema@ingema.sk

TUN

HANDASSA GROUP
48 Av. Taieb Mhiri Imm. Les Jasmins apt. n°5.
2080 Ariana / Tunisia
t : +216-(0)71-702-272
e: info@handassagroup.com.tn

TUR

Franke Mutfak ve Banyo Sistemleri San. ve
Tic. A.S
Gebze Organize Sanayi Bölgesi
Tembelova Alanı 3500 sokak No: 3503
Gebze, Kocaeli / Türkiye
t: +90-(0)262-644-6595
e: ws-info.tr@franke.com

UAE

Franke L.L.C
P.O. Box 14511
Ras Al Khaimah / United Arab Emirates
t: +971-(0)7-244-4940
e: ws-info.ae@franke.com

UKR

Franke Ukraina LLC
7D, Zdolbunivska Str.
Kyiv 02081 / Ukraine
t: +380-(0)44-492-0015
e: ws-info.ua@franke.com

Other Countries:

Franke Ges.m.b.H
Oberer Achdamm 52
6971 Hard / Austria
t: +43-(0)5574-6735-0
e: ws-info.int@franke.com